



**7-INCH DIGITAL MEDIA STATION**

**iLX-705D**

**HALO9 9-INCH DIGITAL MEDIA STATION**

**iLX-F905D**

**HALO11 11-INCH DIGITAL MEDIA STATION**

**iLX-F115D**

**9-INCH SEPARATE DIGITAL MEDIA STATION**

**i905**

EN

DE

FR

ES

IT

RU

QUICK REFERENCE GUIDE  
KURZANLEITUNG  
GUIDE DE RÉFÉRENCE RAPIDE  
GUÍA DE REFERENCIA RÁPIDA  
GUIDA RAPIDA  
КРАТКОЕ СПРАВОЧНОЕ РУКОВОДСТВО



# Contents

WARNING .....	2
CAUTION .....	3
Getting Started .....	4
Apple CarPlay Operation (Optional).....	8
Android Auto™ (Optional).....	8
Radio/RDS Operation .....	9
DAB/DAB+/DMB Operation .....	9
USB Flash drive Operation (Optional).....	10
iPod mode on iPhone (Optional).....	11
Hands-Free Phone Control .....	12
Installation.....	13
Connections.....	18
Specifications .....	21

## IMPORTANT

Please record the serial number of your unit in the space provided below and keep it as a permanent record.

SERIAL NUMBER: \_\_\_\_\_

ISO SERIAL NUMBER: AL \_\_\_\_\_

INSTALLATION DATE: \_\_\_\_\_

INSTALLATION TECHNICIAN: \_\_\_\_\_

PLACE OF PURCHASE: \_\_\_\_\_

For details on all functions, refer to the Owner's Manual published on our website at <https://www.alpine-europe.com/alpine-europe.html> If required, an ALPINE dealer will readily provide you with a print out of the Owner's Manual published on the website.

## WARNING



### WARNING

**This symbol means important instructions. Failure to heed them can result in serious injury or death.**

#### **INSTALL THE PRODUCT CORRECTLY SO THAT THE DRIVER CANNOT WATCH TV/VIDEO UNLESS THE VEHICLE IS STOPPED AND THE PARKING BRAKE IS APPLIED.**

It is dangerous for the driver to watch TV/Video while driving a vehicle. Installing this product incorrectly enables the driver to watch TV/Video while driving. This may cause a distraction, preventing the driver from looking ahead, thus causing an accident. The driver or other people could be severely injured.

#### **DO NOT WATCH VIDEO WHILE DRIVING.**

Watching the video may distract the driver from looking ahead of the vehicle and cause an accident.

#### **DO NOT OPERATE ANY FUNCTION THAT TAKES YOUR ATTENTION AWAY FROM SAFELY DRIVING YOUR VEHICLE.**

Any function that requires your prolonged attention should only be performed after coming to a complete stop. Always stop the vehicle in a safe location before performing these functions. Failure to do so may result in an accident.

#### **KEEP THE VOLUME AT A LEVEL WHERE YOU CAN STILL HEAR OUTSIDE NOISES WHILE DRIVING.**

Excessive volume levels that obscure sounds such as emergency vehicle sirens or road warning signals (train crossings, etc.) can be dangerous and may result in an accident. LISTENING AT LOUD VOLUME LEVELS IN A CAR MAY ALSO CAUSE HEARING DAMAGE.

#### **MINIMIZE DISPLAY VIEWING WHILE DRIVING.**

Viewing the display may distract the driver from looking ahead of the vehicle and cause an accident.

#### **DO NOT DISASSEMBLE OR ALTER.**

Doing so may result in an accident, fire or electric shock.

#### **USE ONLY IN CARS WITH A 12 VOLT NEGATIVE GROUND.**

(Check with your dealer if you are not sure.) Failure to do so may result in fire, etc.

#### **KEEP SMALL OBJECTS SUCH AS SCREWS OUT OF THE REACH OF CHILDREN.**

Swallowing them may result in serious injury. If swallowed, consult a physician immediately.

#### **USE THE CORRECT AMPERE RATING WHEN REPLACING FUSES.**

Failure to do so may result in fire or electric shock.

#### **DO NOT BLOCK VENTS OR RADIATOR PANELS.**

Doing so may cause heat to build up inside and may result in fire.

#### **USE THIS PRODUCT FOR MOBILE 12V APPLICATIONS.**

Use for other than its designed application may result in fire, electric shock or other injury.

#### **MAKE THE CORRECT CONNECTIONS.**

Failure to make the proper connections may result in fire or product damage.

#### **BEFORE WIRING, DISCONNECT THE CABLE FROM THE NEGATIVE BATTERY TERMINAL.**

Failure to do so may result in electric shock or injury due to electrical shorts.

#### **DO NOT ALLOW CABLES TO BECOME ENTANGLED IN SURROUNDING OBJECTS.**

Arrange wiring and cables in compliance with the manual to prevent obstructions when driving. Cables or wiring that obstruct or hang up in places such as the steering wheel, gear lever, brake pedals, etc. can be extremely hazardous.

#### **DO NOT SPLICE INTO ELECTRICAL CABLES.**

Never cut away cable insulation to supply power to other equipment. Doing so will exceed the current carrying capacity of the wire and result in fire or electric shock.

#### **DO NOT DAMAGE PIPE OR WIRING WHEN DRILLING HOLES.**

When drilling holes in the chassis for installation, take precautions so as not to contact, damage or obstruct pipes, fuel lines, tanks or electrical wiring. Failure to take such precautions may result in fire.

#### **DO NOT USE BOLTS OR NUTS IN THE BRAKE OR STEERING SYSTEMS TO MAKE GROUND CONNECTIONS.**

Bolts or nuts used for the brake or steering systems (or any other safety-related system), or tanks should NEVER be used for installations or ground connections. Using such parts could disable control of the vehicle and cause fire etc.

#### **DO NOT INSTALL IN LOCATIONS WHICH MIGHT HINDER VEHICLE OPERATION, SUCH AS THE STEERING WHEEL OR SHIFT LEVER.**

Doing so may obstruct forward vision or hamper movement etc. and results in serious accident.

 **CAUTION**

**This symbol means important instructions. Failure to heed them can result in injury or material property damage.**

---

**HALT USE IMMEDIATELY IF A PROBLEM APPEARS.**

Failure to do so may cause personal injury or damage to the product. Return it to your authorized Alpine dealer or the nearest Alpine Service Center for repairing.

---

**HAVE THE WIRING AND INSTALLATION DONE BY EXPERTS.**

The wiring and installation of this unit requires special technical skill and experience. To ensure safety, always contact the dealer where you purchased this product to have the work done.

---

**USE SPECIFIED ACCESSORY PARTS AND INSTALL THEM SECURELY.**

Be sure to use only the specified accessory parts. Use of other than designated parts may damage this unit internally or may not securely install the unit in place. This may cause parts to become loose resulting in hazards or product failure.

---

**ARRANGE THE WIRING SO IT IS NOT CRIMPED OR PINCHED BY A SHARP METAL EDGE.**

Route the cables and wiring away from moving parts (like the seat rails) or sharp or pointed edges. This will prevent crimping and damage to the wiring. If wiring passes through a hole in metal, use a rubber grommet to prevent the wire's insulation from being cut by the metal edge of the hole.

---

**DO NOT INSTALL IN LOCATIONS WITH HIGH MOISTURE OR DUST.**

Avoid installing the unit in locations with high incidence of moisture or dust. Moisture or dust that penetrates into this unit may result in product failure.

---

## Getting Started

### Controls Position

The screen design used in the Quick Reference Guide may differ from the actual screen.

#### ■ iLX-705D

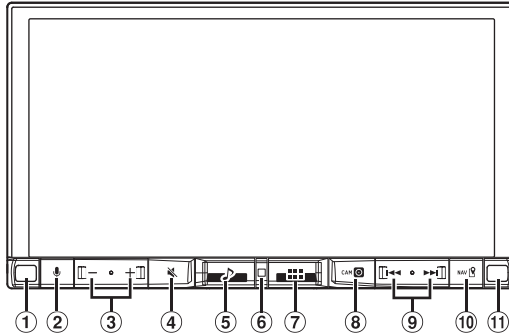

#### ■ iLX-F905D/iLX-F115D

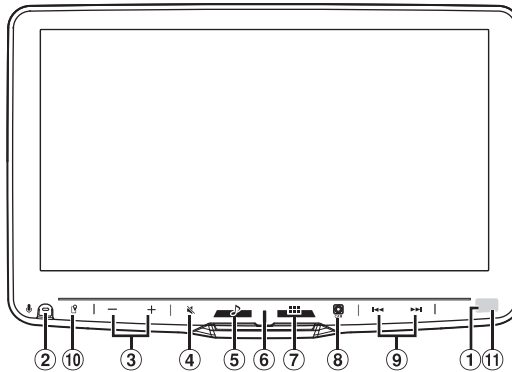

- ① **Dimmer Sensor**  
Sense the brightness of the car interior.
- ② **🗨️ button**  
Activate Siri function or voice recognition mode while Apple CarPlay or Android Auto is connected.
- ③ **— / + (DOWN/UP) button**  
Adjusts the volume.
- ④ **🔇 (MUTE) button**  
Activates/deactivates MUTE mode.  
Press and hold this button for at least 2 seconds to turn off the screen/button illumination.
- ⑤ **🎵 (Audio) button**  
Displays the Audio playback screen.  
Audio sources can be switched while the Audio playback screen is displayed.
- ⑥ **Power indicator**
- ⑦ **🏠 (HOME) button**  
Activates the HOME screen.  
The Sound Setup screen is displayed while the HOME screen is displayed.  
Press and hold this button for at least 2 seconds to turn the power off.
- ⑧ **📷 (CAM) button**  
Displays the image of Camera2 (Rear/Front/Side/Other) or Camera1 (Rear).  
Press for 1 second or more to return to the previous screen.
- ⑨ **⏮️/⏭️ button**  
Press to seek up/down a station in radio mode or up/down a track, etc., in other audio/visual sources.
- ⑩ **📍 (MAP) button**  
Displays the map screen for Apple CarPlay / Android Auto when Apple CarPlay or Android Auto is connected.  
Displays the navigation map screen when the optional Navigation Stick (KTX-NS01EU) is connected.
- ⑪ **Remote Sensor**  
Point the remote control transmitter towards the remote sensor within a range of 2 meters.

## Turning Power On or Off

### 1 Turn the ignition key to the ACC or ON position.

The system is turned on.

- When using the system for the first time, the HOME screen is displayed.



## CAUTION (iLX-F905D/iLX-F115D only)

**To adjust the display angle, hold the center of the top and bottom of the display to move it.**

**To protect the display, do not hold the left and right ends to move it.**

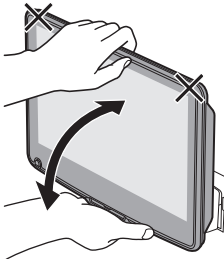

## About the HOME Screen

Select the audio source on the HOME screen to perform various settings and operations of the function.

### 1 Press the (HOME) button.

The HOME screen is displayed.

#### ■ Normal mode screen example

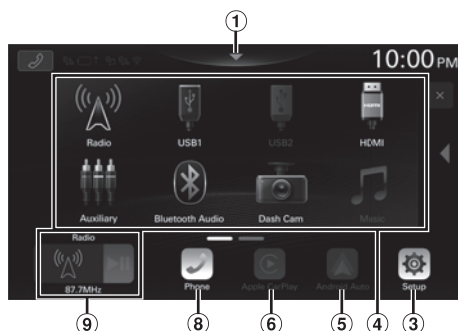

#### ■ Enhanced Text mode screen example

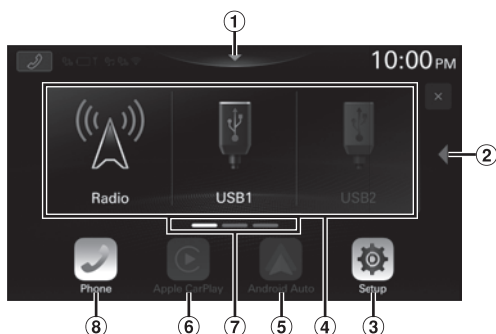

① **Touch to display the Sound Setup screen.**

② **Touch to change the page.**

Pages can also be changed by swiping the HOME screen horizontally with your finger.

③ **Setup button**

Displays the Setup screen.

④ **Audio source select area**

Touch your desired source icon to change the audio source.

⑤ **Android Auto button**

Displays the Android Auto screen, high light displayed when an Android Smartphone installed Android Auto App is connected.

⑥ **Apple CarPlay button**

Displays the Apple CarPlay screen, high light displayed when Apple CarPlay is turned on and an iPhone 6s or later is connected.

⑦ **HOME screen navigation**

⑧ **Phone button**

Displays the Phone menu screen. The Device List screen is displayed when a Hands-free Phone, Apple CarPlay or Android Auto device is not connected.

⑨ **Thumbnail window for the current source**

Source name, artwork and title information are displayed. Touch  to play/pause a track or video.



## Setting the Home Screen Type

---

The Home screen can be changed to the Enhanced Text mode.

### 1 Press the (HOME) button.

The HOME screen is displayed.

### 2 Touch [Setup].

The Setup screen is displayed.

### 3 Touch [System].

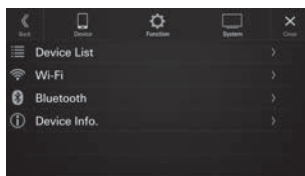

### 4 Touch [Home Screen Type].

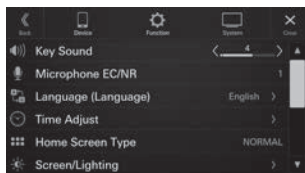

### 5 Touch [NORMAL] or [Enhanced Text].

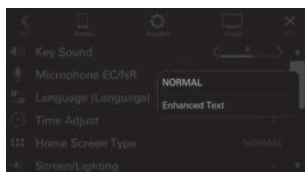

## Apple CarPlay Operation (Optional)

Apple CarPlay is a smarter, safer way to use your iPhone in the car. Apple CarPlay takes the things you want to do with your iPhone while driving and puts them right on this unit. You can get directions, make calls, send and receive messages, and listen to music, all in a way that allows you to stay focused on the road.

### 1 Press the (HOME) button.

The HOME screen is displayed.

### 2 Touch [Apple CarPlay].

The Apple CarPlay screen is displayed.

- Refer to "Apple CarPlay" in the Owner's Manual for information on how to operate Apple CarPlay.

## Android Auto™ (Optional)

Android Auto brings your favorite smartphone apps into one place, making it easier for drivers to access their favorite navigation, media, and communication apps on the road while minimizing the distractions. Talk to Google on Android Auto™ and get things done with your voice so you can keep your eyes on the road and hands on the wheel. Easily send messages, get directions, control media and more. Just short-press or long-press the voice control button on your steering wheel.

### 1 Press the (HOME) button.

The HOME screen is displayed.

### 2 Touch [Android Auto].

The Android Auto screen is displayed.

- Refer to "Android Auto" in the Owner's Manual for information on how to operate Android Auto.

## Radio/RDS Operation

### Displays the Phone screen

The Device List screen is displayed when a Phone, CarPlay or Android Auto device is not connected.

### Preset button

Displays the preset stations with a short touch.  
Touch for at least 2 seconds to memorise the current station as a preset station.

### Switches a Seek mode

**Touch for at least 1 second to memorises stations automatically**



TP/EON indicator

Switches band

Information display

**Increases frequency**  
Touch and hold to change the frequency continuously.

**Displays the Radio setting screen**

**Decreases frequency**  
Touch and hold to change the frequency continuously.

**Traffic Information mode On/Off**

- The patterns of some keys in the Quick Reference Guide may differ from the actual screen.

## DAB/DAB+/DMB Operation

### Slide Show

### Displays the Phone screen

The Device List screen is displayed when a Phone, CarPlay or Android Auto device is not connected.

### Preset button

Displays the preset stations with a short touch.  
Touch for at least 2 seconds to memorise the current station as a preset station.

### Switches a Seek mode

### Displays the search screen

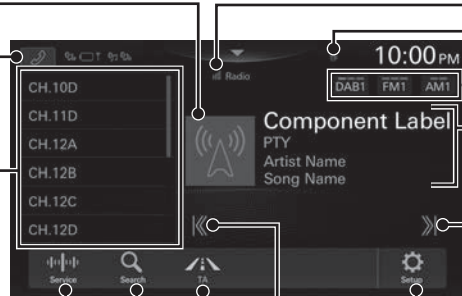

Signal Strength indicator

TP indicator

Switches band

Information display

**Increases frequency**

**Displays the Radio setting screen**

**Decreases frequency**

**Traffic Information mode On/Off**

- The patterns of some keys in the Quick Reference Guide may differ from the actual screen.

## USB Flash drive Operation (Optional)

You can play back music files (MP3/WMA/AAC/FLAC/WAV/APE) and video files (MP4/MOV/FLV/MKV) stored in a USB flash drive on the internal player of this system.

### USB Audio main screen example

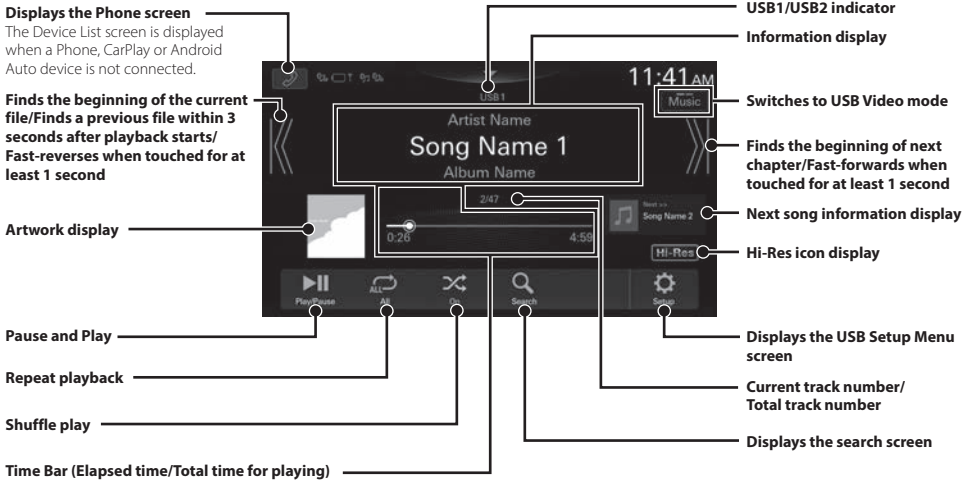

- The patterns of some keys in the Quick Reference Guide may differ from the actual screen.

### Searching for a Music File

For example: Searching by Artist name

- 1 Touch [Q (Search)] during playback.
- 2 Touch [Artists].

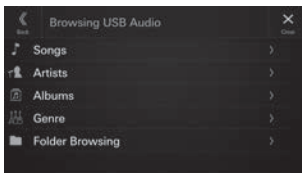

- 3 Touch the desired artist's name.

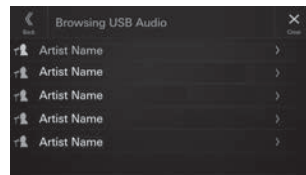

- 4 Touch the desired album's name.
- 5 Touch the desired song's name.

The selected song is played back.

## iPod mode on iPhone (Optional)

A separately sold Lightning to USB cable is required depending on the type of iPhone.

### Displays the Phone screen

The Device List screen is displayed when a Phone, CarPlay or Android Auto device is not connected.

**Finds the beginning of the current file/Finds a previous file within 3 seconds after playback starts/Fast-reverses when touched for at least 1 second**

Artwork display

Pause and Play

Repeat playback

Shuffle play

Time Bar (Elapsed time/Total time for playing)

Information display

Finds the beginning of the next file/Fast-forwards when touched for at least 1 second

Next song information display

Displays the iPod Setup Menu screen

Current track number/  
Total track number

Displays the search screen

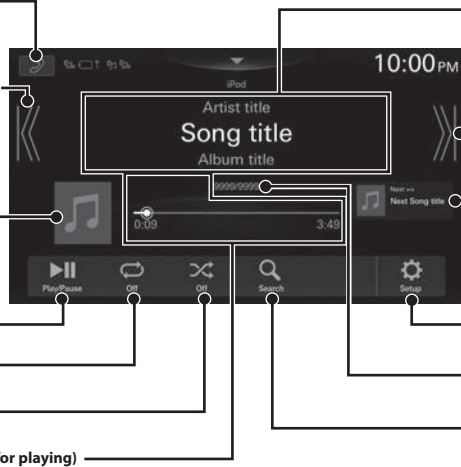

- This unit supports iPhone (iPhone 6s or later) only. For using music playback only, set the "Apple CarPlay" setting to "Off" before connecting with your iPhone.
- The patterns of some keys in the Quick Reference Guide may differ from the actual screen.

## Searching for a Music File

For example: Searching by Artist name

**1** Touch [Q (Search)] during playback.

**2** Touch [Artists].

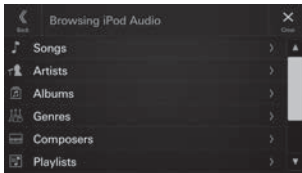

**3** Touch the desired artist's name.

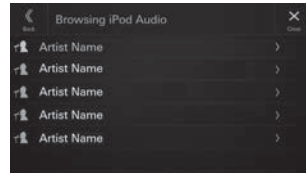

**4** Touch the desired album's name.

**5** Touch the desired song's name.

The selected song is played back.

## Hands-Free Phone Control

The unit can connect with up to two hands-free phones.

### How to connect to a Bluetooth compatible device (Pairing)

To display the Setup HOME screen:

- Bring your vehicle to a complete stop at a safe location. Engage the parking brake.

**1 Touch [Setup] on the HOME screen.**

**2 Touch [Device].**

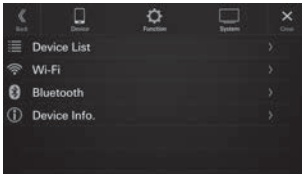

**3 Touch [Device List].**

**4 Touch [Add New Device].**

A search for devices to connect wirelessly to the unit starts.

The Search List is displayed, and the list of searched devices is displayed.

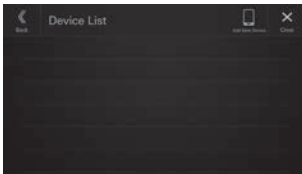

**5 Touch a device to connect in the list.**

**6 When a code is displayed on the device, check that the code is the same as the one on the screen of the unit, and touch [Yes].**

When the device connection is complete, a message appears and the device returns to normal mode.

### Answering a Call

**1 An incoming call triggers the ringtone and an incoming call display.**



**2 Touch [Answer].**

The call starts.



### Hanging up the Telephone

**1 Touch [End Call].**

The call finishes.

# Installation

## Note on installation

- Install at an angle between horizontal and 30°. Note that installing at an angle outside of this range will result in a loss of performance and possible damage.

### <iLX-705D>

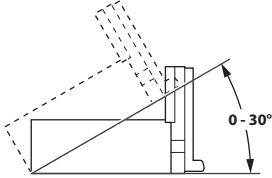

### <iLX-F905D/iLX-F115D>

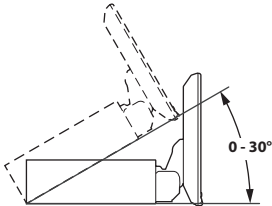

- Do not block the unit's heat sink, which would prevent air circulation. If blocked, heat will accumulate inside the unit and may cause a fire.

Air ventilation hole

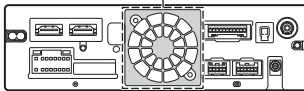

Rear of the Unit

- When installing the display unit and main unit, do not touch the connectors with your hands. (iLX-F905D/iLX-F115D only)

<Display unit>

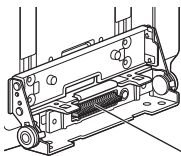

<Main unit>

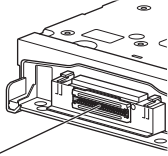

Connectors

## Mounting the Microphone

For safe use, make sure of the following:

- Location is stable and firm.
- Driver's view and operations are not obstructed.
- Microphone is located where the driver's voice can be easily picked up.

When you speak into the microphone, you should not have to change your driving posture. This may cause a distraction, taking your attention away from safely driving your vehicle. Carefully consider direction and distance while mounting the microphone. Confirm that the driver's voice can be easily picked up at the selected location.

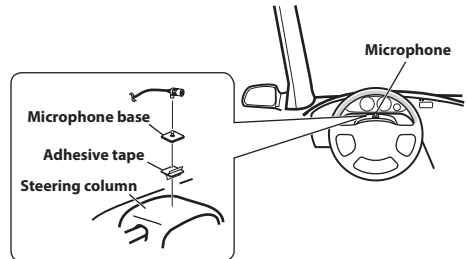

## Mounting the GPS Antenna inside the vehicle

- 1 Clean the mounting location.
- 2 Put on the GPS Antenna mounting plate.
- 3 Mount the GPS Antenna.

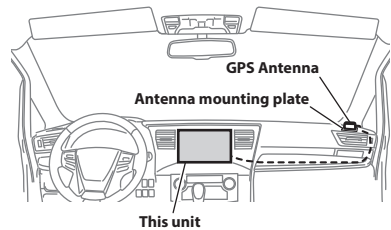

- Do not mount the GPS Antenna inside the centre console.
  - Mount the GPS Antenna on a flat plane of the dash board or rear tray.
  - Make sure the GPS Antenna is not covered (obstructed) by any metallic surface or object.

- If the GPS Antenna is mounted near the unit, the reception becomes poor, and the location of your vehicle may not be displayed correctly.
  - Mount the GPS Antenna far away enough from the unit.
  - Bundle the GPS Antenna cable away from the rear of the unit.
- Some thermal reflection type or thermal absorption type glass may interrupt high frequency waves. If reception is poor with the antenna installed inside the car, try to mount the antenna outside the car.

## Note on using HDMI Connection Cables

When using HDMI connection cables, secure the cables to the HDMI Terminals with the supplied HDMI Fixation Bracket.

- 1 **Secure the HDMI Fixation Bracket with the screw (A).**

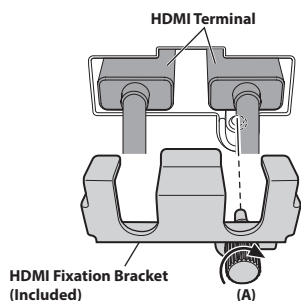

## Adjusting the display position (iLX-F905D/iLX-F115D)

Depending on the vehicle, the front-back display position differs. To adjust the front-back position, set the slider to the forward position. Default setting: Back position

### Front-back position

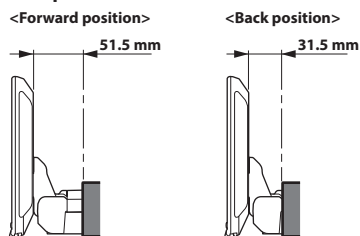

- 1 **Remove 4 hexagon bolts from both sides of the unit.**

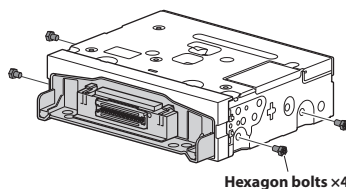

- 2 **Pull out the slider to the forward position. (To return the slider to the back position, push it in.)**

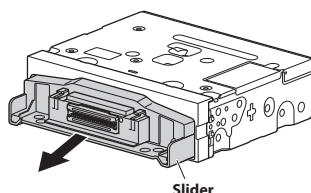

- 3 **Install 4 hexagon bolts to secure the slider.**

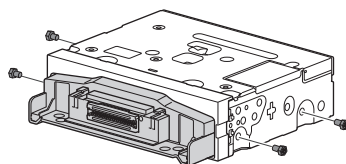

## Installing the Unit (iLX-705D)

- 1 **Mount the original mounting bracket to the unit using the supplied screws.**

If you do not have the original mounting bracket, mount the Double din KIT\* (provided with the side mounting bracket), etc. to the main unit.

\* Sold separately.

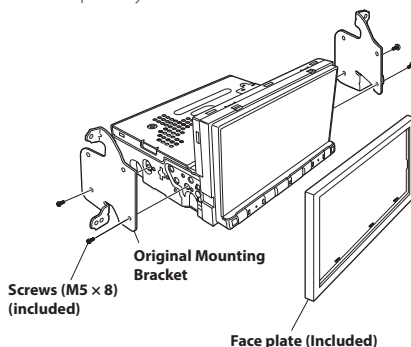



**2** Connect all other leads of the unit according to details described in the “Connections” (page 18).

**3** Mounting the unit in a car.

- Fix the cables carefully. Do not damage them by tucking them into movable parts, such as a seat rail, or by locating them against sharp or pointed edges.

## Installing the Unit (iLX-F905D/ iLX-F115D)

**1** Mount the original mounting bracket to the main unit using the supplied screws.

- If you do not have the original mounting bracket, mount the Double din KIT\* (provided with the side mounting bracket), etc. to the main unit.

\* Sold separately.

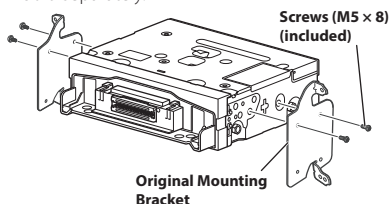

**2** Connect all other leads of the main unit according to details described in the “Connections” (page 18).

**3** Mount the unit in a car.

- Fix the cables carefully. Do not damage them by mounting them into movable parts, such as the seat rail, or by locating them against sharp or pointed edges.

## Adjust the up-down position of the Display unit (iLX-F905D/iLX-F115D)

Adjust the up-down position of the display according to the mounting position on the vehicle before mounting the display unit.  
Default setting: 0 mm

**1** Remove the 4 screws on the rear of the display unit, then adjust the up-down position.

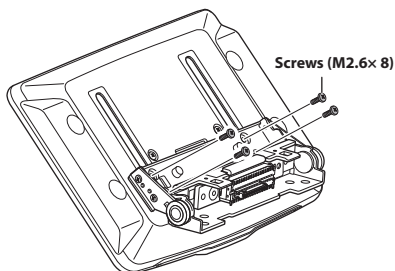

When the vertical position of the display unit is decided, fix it with the 4 screws you removed.

**2** Attach the Sheet Rear in a position that aligns with the up-down position of the display unit.

Sheet Rear (Included)	up-down position
2x50 mm:	for up-down position 0 mm or -60mm
2x35 mm:	for up-down position -15 mm or -45mm
2x20 mm:	for up-down position -30 mm

**0 mm**

Sheet Rear (2x50 mm)

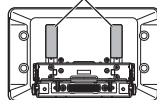

**-15 mm**

Sheet Rear (2x35 mm)

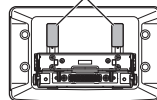

**-30 mm**

Sheet Rear (2x20 mm)

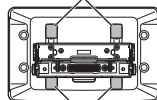

**-45 mm**

Sheet Rear (2x35 mm)

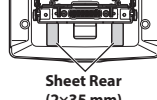

Sheet Rear (2x20 mm)

-60 mm

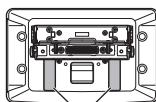

Sheet Rear  
(2×50 mm)

- 3** Attach the Cover Rear to the rear of the display unit using 2 screws (M2.6×6). Secure the screws, then attach the Sheet caps.

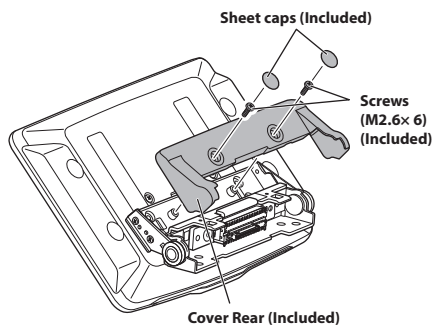

## Install the display unit (iLX-F905D/ iLX-F115D)

- 1** Fix the Display unit to the slider of the main unit using 4 screws (M5×8).

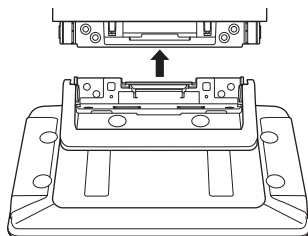

Screws (M5×8) (Included)

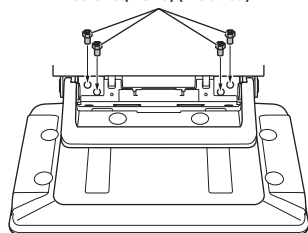

## CAUTION

Do not adjust the display angle when the display unit is not fixed to the slider of the main unit using 4 screws (M5 × 8). Doing so may not turn power on.

- 2** Mount the Power Plate.

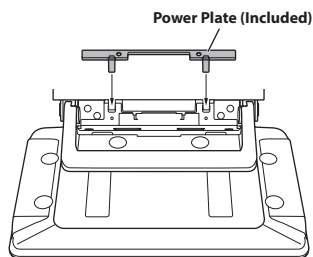

- If the Power Plate is not mounted, the display unit may not be turned power on. Make sure to mount it.

- 3** Mount the Cover Hinge using 2 screws (M3×4). Secure the screws, then attach the Sheet Hinges.

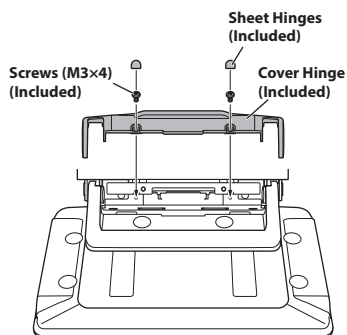

## Connection Diagram of SPST Switch (sold separately)

(If the ACC power supply is not available)

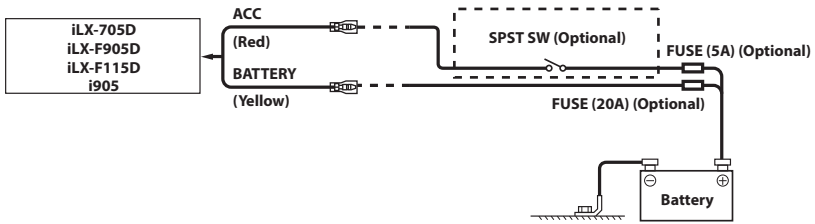

- If your vehicle has no ACC power supply, add an SPST (Single-Pole, Single-Throw) switch (sold separately) and fuse (sold separately).
- The diagram and the fuse amperage shown above are in the case when the unit is used individually.
- If the switched power (ignition) lead of the unit is connected directly to the positive (+) post of the vehicle's battery, the unit draws some current (several hundred milliamperes) even when its switch is placed in the OFF position, and the battery may be discharged.

# Connections

## Connection 1

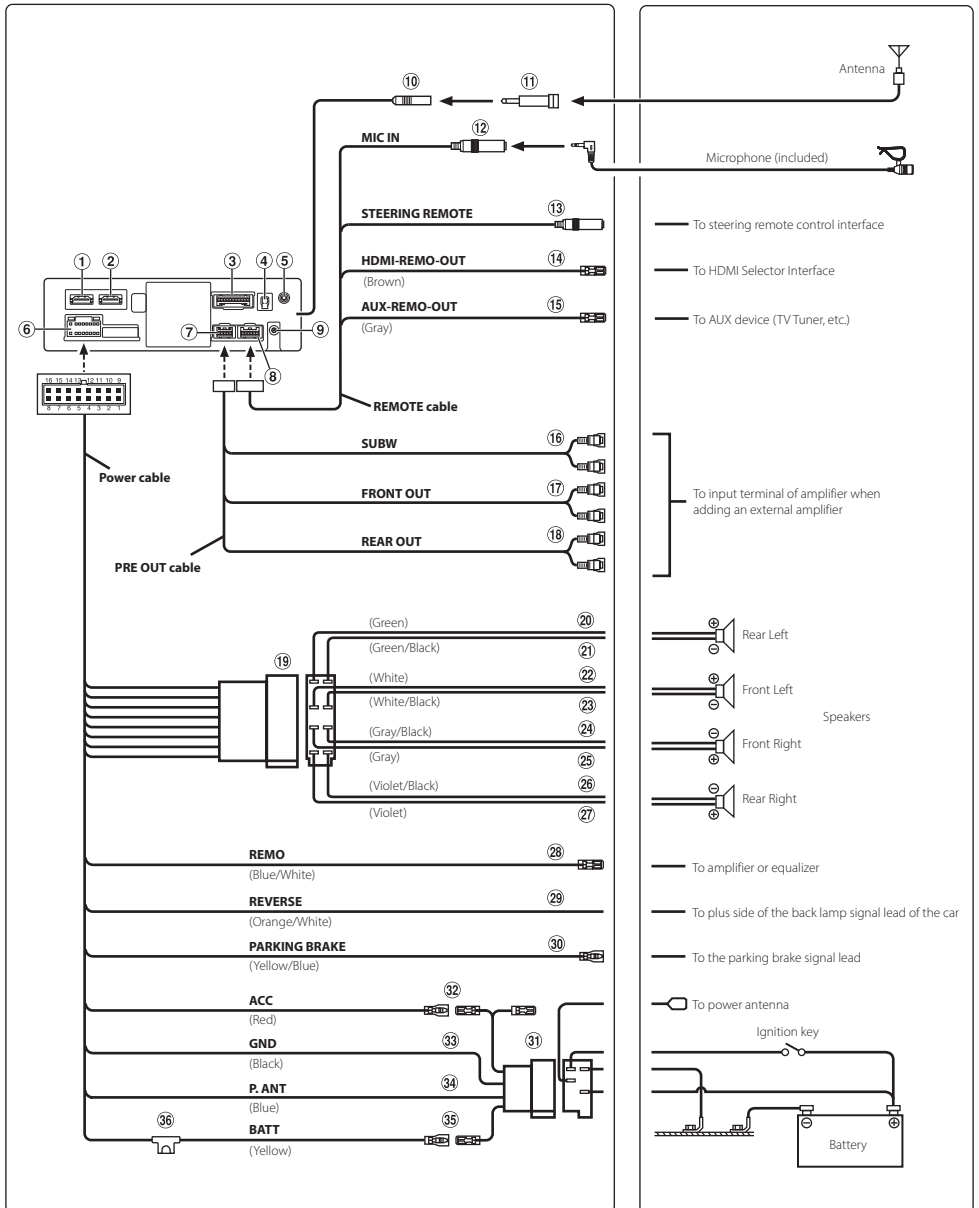

## Connection 2

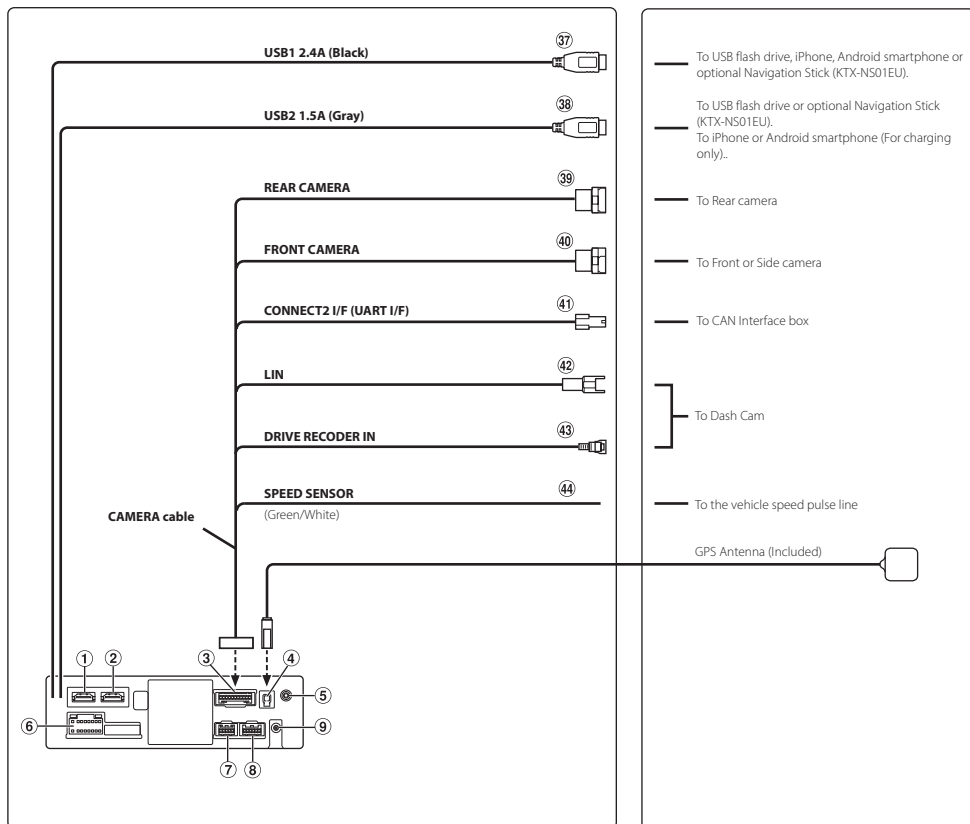

- ① **HDMI Input Connector**
- ② **HDMI Output Connector**
- ③ **CAMERA Connector**
- ④ **GPS Antenna Receptacle**  
Connect to GPS antenna (Included).
- ⑤ **AUX Input Connector**  
Input lead for AUX audio signal.
- ⑥ **Power Supply Connector**
- ⑦ **PRE OUT Connector**
- ⑧ **REM Connector**
- ⑨ **DAB Antenna Connector**  
To DAB Antenna (sold separately).
- ⑩ **Radio Antenna Receptacle**

- ⑪ **ISO/JASO Antenna Adapter (sold separately)**  
ISO/JASO Antenna Adapter may be required, depending on the vehicle.
- ⑫ **MIC Input Connector**  
To microphone (included).
- ⑬ **Steering Remote Control Interface Connector**  
To steering remote control interface. For details about connections, consult your nearest Alpine dealer.
- ⑭ **HDMI-REM-OUT Lead (Brown)**  
Connect this lead to the remote input lead of your HDMI Selector Interface.
- ⑮ **AUX-REM-OUT Lead (Gray)**  
Connect this lead to the remote input lead of your AUX device.

- 16 Subwoofer RCA Connectors**  
RED is right and WHITE is left.
- 17 Front Output RCA Connectors**  
Can be used as Front Output RCA Connectors. RED is right and WHITE is left.
- 18 Rear Output RCA Connectors**  
Can be used as Rear Output RCA Connectors. RED is right and WHITE is left.
- 19 ISO Connector (Speaker Output)**
- 20 Left Rear (+) Speaker Output Lead (Green)**
- 21 Left Rear (-) Speaker Output Lead (Green/Black)**
- 22 Left Front (+) Speaker Output Lead (White)**
- 23 Left Front (-) Speaker Output Lead (White/Black)**
- 24 Right Front (-) Speaker Output Lead (Gray/Black)**
- 25 Right Front (+) Speaker Output Lead (Gray)**
- 26 Right Rear (-) Speaker Output Lead (Violet/Black)**
- 27 Right Rear (+) Speaker Output Lead (Violet)**
- 28 Remote Turn-On Lead (Blue/White)**  
Connect this lead to the remote turn-on lead of your amplifier or signal processor.
- 29 Reverse Lead (Orange/White)**
- 30 Parking Brake Lead (Yellow/Blue)**  
Connect this lead to the power supply side of parking brake switch to transmit the parking brake status signals to the unit.
- 31 ISO Power Supply Connector**
- 32 Switched Power Lead (Ignition) (Red)**  
Connect this lead to an open terminal on the vehicle's fuse box or another unused power source that provides (+) 12V only when the ignition is turned on or in the accessory position.
- 33 Ground Lead (Black)**  
Connect this lead to a good chassis ground on the vehicle.  
Make sure the connection is made to bare metal and is securely fastened using the sheet metal screw provided.
- 34 Power Antenna Lead (Blue)**  
Connect this lead to the +B terminal of your power antenna, if applicable.  
• This lead should be used only for controlling the vehicle's power antenna. Do not use this lead to turn on an amplifier or a signal processor, etc.
- 35 Battery Lead (Yellow)**  
Connect this lead to the positive (+) post of the vehicle's battery.
- 36 Fuse Holder (15A)**
- 37 USB1 Connector 2.4A (Black)**  
To USB flash drive, iPhone, Android smartphone or optional Navigation Stick (KTX-NS01EU).
- 38 USB2 Connector 1.5A (Gray)**  
To USB flash drive or optional Navigation Stick (KTX-NS01EU).  
To iPhone or Android smartphone (For charging only).
- 39 REAR CAMERA Input Connector**  
Use when connecting a rear camera.
- 40 FRONT CAMERA Input Connector**  
Use when connecting a front camera or side camera.
- 41 Connect2 (UART) Connector**  
To Interface Box.
- 42 LIN Connector**  
Connect this lead to the LIN connector of the Dash Cam.
- 43 Drive Recorder Input Connector**  
Input lead for Dash Cam video signal.
- 44 Speed Sensor Lead (Green/White)**  
Improper connection of the speed pulse line may cause important safety features of the vehicle to fail (such as the brakes or air bags). Such failures may result in an accident and loss of life. We strongly recommend that the installation be performed by a trained, authorized Alpine dealer.

# Specifications

## MONITOR SECTION

Screen Size	7" (iLX-705D) 9" (iLX-F905D) 11" (iLX-F115D) 9" (i905)
Operation System	TFT active matrix
Number of Picture Elements	2,764,800 pcs. (1280 × 720 × RGB)
Effective Number of Picture Elements	99% or more
Color system	NTSC / PAL
Illumination System	LED

## FM TUNER SECTION

Tuning Range	87.5 – 108.0 MHz
Mono Usable Sensitivity	8.1 dBf (0.7 μV/75 ohms)
50 dB Quieting Sensitivity	12 dBf (1.1 μV/75 ohms)
Alternate Channel Selectivity	80 dB
Signal-to-Noise Ratio	65 dB
Stereo Separation	35 dB

## AM TUNER SECTION

Tuning Range	531 – 1,602 kHz
Usable Sensitivity	25.1 μV/28 dBf

## DAB SECTION

Tuning Range	174.928 – 239.2 MHz
Usable Sensitivity	-100 dBm
Signal-to-Noise Ratio	90 dB

## USB1 SECTION

USB requirements	USB 2.0
Max. Power Consumption	2,400 mA
USB Class	USB (Mass Storage Class)
File System	FAT16 / 32, exFAT
Number of Channels	2-Channels (Stereo)
Frequency Response*1	5 – 40,000 Hz (±1 dB)
Total Harmonic Distortion	0.005% (at 1 kHz)
Dynamic Range	95 dB (at 1 kHz)
Signal-to-Noise Ratio	95 dB
Channel Separation	90 dB (at 1 kHz)

\*1 Frequency response may differ depending on the encoder software/bit rate.

## USB2 SECTION

USB requirements	USB 2.0
Max. Power Consumption	1,500 mA (CDP Support)
USB Class	USB (Mass Storage Class)
File System	FAT16 / 32, exFAT
Number of Channels	2-Channels (Stereo)
Frequency Response*1	5 – 40,000 Hz (±1 dB)
Total Harmonic Distortion	0.005% (at 1 kHz)
Dynamic Range	95 dB (at 1 kHz)
Signal-to-Noise Ratio	95 dB
Channel Separation	90 dB (at 1 kHz)

\*1 Frequency response may differ depending on the encoder software/bit rate.

## HDMI SECTION

Input Format	720p / 480p / VGA
Output Format	720p / 480p

## Bluetooth SECTION

Bluetooth Specification	Bluetooth V4.2 (2,402 - 2,480 MHz)
Output Power	+4.0 dBm/2.51 mW Ave. (Power class 2)
Profile	HFP (Hands-Free Profile) OPP (Object Push Profile) PBAP (Phone Book Access Profile) SPP (Serial Port Profile) A2DP (Advanced Audio Distribution Profile) AVRCP (Audio/Video Remote Control Profile)

## GPS SECTION

Reception Frequency	1575.42 + / - 1.023 MHz
Reception Sensitivity (Search)	-136 dB max.

## Wi-Fi SECTION

Frequency Ranges	IEEE 802.11 b/g/n (2.4 GHz) IEEE 802.11 a/n/ac (5 GHz)
Channels	1 – 13 ch (2.4 GHz) 149 – 165 ch (5 GHz)
Frequency Band	2401 – 2483 MHz (2.4 GHz) 5725 – 5850 MHz (5 GHz)
Output Power (2.4 GHz)	Max. 18 dBm
Output Power (5 GHz)	Max. 13 dBm (11 a) Max. 12 dBm (11 n/ac)
Security Protocols	WPA3 / WPA2-PSK (TKIP, AES)

## GENERAL

Power Requirement	14.4V DC (11–16 V allowable)
Operating temperature	-20°C to +60°C
Power Output	50 W × 4
Maximum Current Consumption	15 A
Audio output level	
Preout (Front, Rear):	4V/10k ohms (max.)
Preout (Subwoofer):	4V/10k ohms (max.)
Weight	1.4 kg (iLX-705D) 2.3 kg (iLX-F905D) 2.6 kg (iLX-F115D) 1.7 kg (i905)

## CHASSIS SIZE

	iLX-705D	iLX-F905D	iLX-F115D	i905
Width	178 mm	178 mm	178 mm	178 mm
Height	50 mm	50 mm	50 mm	50 mm
Depth	149.6 mm	149.6 mm	149.6 mm	142 mm

## DISPLAY SIZE

	iLX-705D	iLX-F905D	iLX-F115D	i905
Width	171 mm	232.5 mm	268.9 mm	214.7 mm
Height	96 mm	151.1 mm	178 mm	136.6 mm
Depth	17.7 mm	54.7 mm	54.7 mm	29.9 mm

- *Due to continuous product improvement, specifications and design are subject to change without notice.*
- *The LCD panel is manufactured using an extremely high precision manufacturing technology. Its effective pixel ratio is over 99.99%. This means that there is a possibility that 0.01% of the pixels could be either always ON or OFF.*

- Windows Media, and the Windows logo are trademarks, or registered trademarks of Microsoft Corporation in the United States and/or other countries.
- Apple, iPhone, iPod, Lightning and Siri are trademarks of Apple Inc., registered in the U.S. and other countries. App Store is a service mark of Apple Inc.
- Use of the Made for Apple and Works with Apple badges means that an accessory has been designed to connect specifically to the Apple product(s) identified in the Made for Apple badge and to work specifically with the technology identified in the Works with Apple badge, and has been certified by the developer to meet Apple performance standards. Apple is not responsible for the operation of this device or its compliance with safety and regulatory standards. Please note that the use of this accessory with an Apple product may affect wireless performance.
- Use of the Apple CarPlay logo means that a vehicle user interface meets Apple performance standards. Apple is not responsible for the operation of this vehicle or its compliance with safety and regulatory standards. Please note that the use of this product with iPhone may affect wireless performance.
- Google, Android, Google Play and Android Auto are trademarks of Google LLC.  
To use Android Auto on your car display, you'll need an Android phone running Android 6.0 or higher, an active data plan, and the Android Auto app.
- The terms HDMI and HDMI High-Definition Multimedia Interface, and the HDMI Logo are trademarks or registered trademarks of HDMI Licensing Administrator, Inc. in the United States and other countries.
- The Bluetooth® word mark and logos are registered trademarks owned by Bluetooth SIG, Inc. and any use of such marks by ALPS ALPINE CO., LTD. is under license. Other trademarks and trade names are those of their respective owners.
- The Wi-Fi CERTIFIED™ Logo is a registered trademark of Wi-Fi Alliance®.
- LDAC and LDAC logo are trademarks of Sony Corporation.
- The product with this logo is conformed to High-Resolution Audio standard defined by Japan Audio Society. This logo is used under license from Japan Audio Society.
- MQA and the Sound Wave Device are registered trademarks of MQA Limited © 2016.

Made for iPhone SE (2nd generation), iPhone 11 Pro Max, iPhone 11 Pro, iPhone 11, iPhone XS Max, iPhone XS, iPhone XR, iPhone X, iPhone 8 Plus, iPhone 8, iPhone 7 Plus, iPhone 7, iPhone SE, iPhone 6s Plus, iPhone 6s.



## SIMPLIFIED EU DECLARATION OF CONFORMITY

Hereby, ALPS ALPINE EUROPE GmbH (<https://www.alpine.de/>) declares that the radio equipment type Music Halo (iLX-705D/iLX-F905D/iLX-F115D/i905) is in compliance with Directive 2014/53/EU.

The full text of the EU declaration of conformity is available at the following internet address:

<http://www.alpine.com/e/research/doc/>

Compliant with UNECE Regulation 10 (E-Mark)



Hereby, ALPS ALPINE EUROPE GmbH (<https://www.alpine.co.uk/>) declares that the radio equipment type Music Halo (iLX-705D/iLX-F905D/iLX-F115D/i905) is in compliance with Radio Equipment Regulations 2017.

The full text of the declaration of conformity is available at the following internet address:

<http://www.alpine.com/e/research/doc/>



[EN] English	Hereby, ALPS ALPINE CO., LTD. declares that the radio equipment type Music Halo (iLX-705D/iLX-F905D/iLX-F115D/i905) is in compliance with the relevant statutory requirements. The full text of the UK declaration of conformity is available at the following internet address: <a href="http://www.alpine.com/e/research/doc/">http://www.alpine.com/e/research/doc/</a>
[BG] Bulgarian	С настоящото ALPS ALPINE CO., LTD. декларира, че този тип радиос ъоръжение Music Halo (iLX-705D/iLX-F905D/iLX-F115D/i905) е в съответствие с Директива 2014/53/EC. Цялостният текст на ЕС декларацията за съответствие може да се намери на следния интернет адрес: <a href="http://www.alpine.com/e/research/doc/">http://www.alpine.com/e/research/doc/</a>
[CZ] Czech	Tímto ALPS ALPINE CO., LTD. prohlašuje, že typ rádiového zařízení Music Halo (iLX-705D/iLX-F905D/iLX-F115D/i905) je v souladu se směrnicí 2014/53/EU. Úplné znění EU prohlášení o shodě je k dispozici na této internetové adrese: <a href="http://www.alpine.com/e/research/doc/">http://www.alpine.com/e/research/doc/</a>
[DE] German	Hiermit erklärt ALPS ALPINE CO., LTD., dass der Funkanlagentyp Music Halo (iLX-705D/iLX-F905D/iLX-F115D/i905) der Richtlinie 2014/53/EU entspricht. Der vollständige Text der EU-Konformitätserklärung ist unter der folgenden Internetadresse verfügbar: <a href="http://www.alpine.com/e/research/doc/">http://www.alpine.com/e/research/doc/</a>
[DK] Danish	Hermed erklærer ALPS ALPINE CO., LTD., at radioudstyrstypen Music Halo (iLX-705D/iLX-F905D/iLX-F115D/i905) er i overensstemmelse med direktiv 2014/53/EU. EU-overensstemmelseserklæringens fulde tekst kan findes på følgende internetadresse: <a href="http://www.alpine.com/e/research/doc/">http://www.alpine.com/e/research/doc/</a>
[EE] Estonian	Käesolevaga deklareerib ALPS ALPINE CO., LTD. et käesolev raadioseadme tüüp Music Halo (iLX-705D/iLX-F905D/iLX-F115D/i905) vastab direktiivi 2014/53/EL nõuetele. Eli vastavusdeklaratsiooni täielik tekst on kättesaadav järgmisel internetiaadressil: <a href="http://www.alpine.com/e/research/doc/">http://www.alpine.com/e/research/doc/</a>
[ES] Spanish	Por la presente, ALPS ALPINE CO., LTD. declara que el tipo de equiporadioeléctrico Music Halo (iLX-705D/iLX-F905D/iLX-F115D/i905) es conforme con la Directiva 2014/53/UE. El texto completo de la declaración UE de conformidad está disponible en la dirección Internet siguiente: <a href="http://www.alpine.com/e/research/doc/">http://www.alpine.com/e/research/doc/</a>
[FI] Finnish	ALPS ALPINE CO., LTD. vakuuttaa, että radiolaitetyyppi Music Halo (iLX-705D/iLX-F905D/iLX-F115D/i905) on direktiivin 2014/53/EU mukainen. EU-vaatimustenmukaisuusvakuutuksen täysimittainen teksti on saatavilla seuraavassa internetosoitteessa: <a href="http://www.alpine.com/e/research/doc/">http://www.alpine.com/e/research/doc/</a>

[FR] French	Le soussigné, ALPS ALPINE CO., LTD., déclare que l'équipement radioélectrique du type Music Halo (iLX-705D/iLX-F905D/iLX-F115D/i905) est conforme à la directive 2014/53/UE. Le texte complet de la déclaration UE de conformité est disponible à l'adresse internet suivante : <a href="http://www.alpine.com/e/research/doc/">http://www.alpine.com/e/research/doc/</a>
[GR] Greek	Με την παρούσα ο/η ALPS ALPINE CO., LTD., δηλώνει ότι ο ραδιοεξοπλισμός Music Halo (iLX-705D/iLX-F905D/iLX-F115D/i905) πληροί την οδηγία 2014/53/ΕΕ. Το πλήρες κείμενο της δήλωσης συμμόρφωσης ΕΕ διατίθεται στην ακόλουθη ιστοσελίδα στο διαδίκτυο: <a href="http://www.alpine.com/e/research/doc/">http://www.alpine.com/e/research/doc/</a>
[HR] Croatian	ALPS ALPINE CO., LTD. ovime izjavljuje da je radijska oprema tipa Music Halo (iLX-705D/iLX-F905D/iLX-F115D/i905) u skladu s Direktivom 2014/53/EU. Cjeloviti tekst EU izjave o sukladnosti dostupan je na sljedećoj internetskoj adresi: <a href="http://www.alpine.com/e/research/doc/">http://www.alpine.com/e/research/doc/</a>
[HU] Hungarian	ALPS ALPINE CO., LTD. igazolja, hogy a Music Halo (iLX-705D/iLX-F905D/iLX-F115D/i905) típusú rádióberendezés megfelel a 2014/53/EU irányelvnek. Az EU-megfelelőségi nyilatkozat teljes szövege elérhető a következő internetes címen: <a href="http://www.alpine.com/e/research/doc/">http://www.alpine.com/e/research/doc/</a>
[IE] Irish	Foghraíonn ALPS ALPINE CO., LTD., leis seo go bhfuil an cineál trealaimh raidió Music Halo (iLX-705D/iLX-F905D/iLX-F115D/i905) in oiriúint le Treoir 2014/53/AE. Tá téacs iomlán an dearbhairthe comhréireachta AE ar fáil ag an seoladh idirlín seo a leanas: <a href="http://www.alpine.com/e/research/doc/">http://www.alpine.com/e/research/doc/</a>
[IS] Icelandic	Hér, ALPS ALPINE CO., LTD. lýsir yfir að radióbúnaður tegund Music Halo (iLX-705D/iLX-F905D/iLX-F115D/i905) er í samræmi við tilskipun 2014/53/ESB. The fullur texti af ESB-samræmisýfirlýsing er í boði á eftirfarandi veffangi: <a href="http://www.alpine.com/e/research/doc/">http://www.alpine.com/e/research/doc/</a>
[IT] Italian	Il fabbricante, ALPS ALPINE CO., LTD., dichiara che il tipo di apparecchiatura radio Music Halo (iLX-705D/iLX-F905D/iLX-F115D/i905) è conforme alla direttiva 2014/53/UE. Il testo completo della dichiarazione di conformità UE è disponibile al seguente indirizzo Internet: <a href="http://www.alpine.com/e/research/doc/">http://www.alpine.com/e/research/doc/</a>
[LT] Lithuanian	Aš, ALPS ALPINE CO., LTD., patvirtinu, kad radijo įrenginių tipas Music Halo (iLX-705D/iLX-F905D/iLX-F115D/i905) atitinka Direktyvą 2014/53/ES. Visas ES atitikties deklaracijos tekstas prieinamas šiuo interneto adresu: <a href="http://www.alpine.com/e/research/doc/">http://www.alpine.com/e/research/doc/</a>
[LU] Luxembourgish	ALPS ALPINE CO., LTD., déclare par la présente que l'équipement radio de type Music Halo (iLX-705D/iLX-F905D/iLX-F115D/i905) est conforme à la directive 2014/53/UE. La version intégrale de la déclaration européenne de conformité est disponible à l'adresse Internet suivante: <a href="http://www.alpine.com/e/research/doc/">http://www.alpine.com/e/research/doc/</a>
[LV] Latvian	Ar šo ALPS ALPINE CO., LTD. deklarē, ka radioiekārta Music Halo (iLX-705D/iLX-F905D/iLX-F115D/i905) atbilst Direktīvai 2014/53/ES. Pilns ES atbilstības deklarācijas teksts ir pieejams šādā interneta vietnē: <a href="http://www.alpine.com/e/research/doc/">http://www.alpine.com/e/research/doc/</a>
[MT] Maltese	B'dan, ALPS ALPINE CO., LTD., niddikjara li dan it-tip ta' tagħmir tar-radju Music Halo (iLX-705D/iLX-F905D/iLX-F115D/i905) huwa konformi mad-Direttiva 2014/53/UE. It-test kollu tad-dikjarazzjoni ta' konformità tal-UE huwa disponibbli f'dan l-indirizz tal-Internet li ġej: <a href="http://www.alpine.com/e/research/doc/">http://www.alpine.com/e/research/doc/</a>
[NL] Dutch	Hierbij verklaar ik, ALPS ALPINE CO., LTD., dat het type radioapparaat Music Halo (iLX-705D/iLX-F905D/iLX-F115D/i905) conform is met Richtlijn 2014/53/UE. De volledige tekst van de EU-conformiteitsverklaring kan worden geraadpleegd op het volgende internetadres: <a href="http://www.alpine.com/e/research/doc/">http://www.alpine.com/e/research/doc/</a>

[NO] Norwegian	Herved ALPS ALPINE CO., LTD., erklærer at radioutstyr type Music Halo (iLX-705D/iLX-F905D/iLX-F115D/i905) er i samsvar med direktiv 2014/53/EU. Den fullstendige teksten i EU-erklæring er tilgjengelig på følgende internetadresse: <a href="http://www.alpine.com/e/research/doc/">http://www.alpine.com/e/research/doc/</a>
[PL] Polish	ALPS ALPINE CO., LTD., niniejszym oświadcza, że typ urządzenia radiowego Music Halo (iLX-705D/iLX-F905D/iLX-F115D/i905) jest zgodny z dyrektywą 2014/53/UE. Pełny tekst deklaracji zgodności UE jest dostępny pod następującym adresem internetowym: <a href="http://www.alpine.com/e/research/doc/">http://www.alpine.com/e/research/doc/</a>
[PT] Portuguese	A abaixo assinada, ALPS ALPINE CO., LTD., declara que o presente tipo de equipamento de rádio Music Halo (iLX-705D/iLX-F905D/iLX-F115D/i905) está em conformidade com a Diretiva 2014/53/UE. O texto integral da declaração de conformidade CE está disponível no seguinte endereço de Internet: <a href="http://www.alpine.com/e/research/doc/">http://www.alpine.com/e/research/doc/</a>
[RO] Romanian	Prin prezenta, ALPS ALPINE CO., LTD., declară că tipul de echipamente radio Music Halo (iLX-705D/iLX-F905D/iLX-F115D/i905) este în conformitate cu Directiva 2014/53/UE. Textul integral al declarației UE de conformitate este disponibil la următoarea adresă internet: <a href="http://www.alpine.com/e/research/doc/">http://www.alpine.com/e/research/doc/</a>
[SE] Swedish	Härmed försäkrar ALPS ALPINE CO., LTD., att denna typ av radioutrustning Music Halo (iLX-705D/iLX-F905D/iLX-F115D/i905) överensstämmer med direktiv 2014/53/EU. Den fullständiga texten till EU-försäkran om överensstämmelse finns på följande webbadress: <a href="http://www.alpine.com/e/research/doc/">http://www.alpine.com/e/research/doc/</a>
[SI] Slovenian	ALPS ALPINE CO., LTD., potrjuje, da je tip radijske opreme Music Halo (iLX-705D/iLX-F905D/iLX-F115D/i905) skladen z Direktivo 2014/53/EU. Celotno besedilo izjave EU o skladnosti je na voljo na naslednjem spletnem naslovu: <a href="http://www.alpine.com/e/research/doc/">http://www.alpine.com/e/research/doc/</a>
[SK] Slovak	ALPS ALPINE CO., LTD., týmto vyhlasuje, že rádiové zariadenie typu Music Halo (iLX-705D/iLX-F905D/iLX-F115D/i905) je v súlade so smernicou 2014/53/EÚ. Úplné EÚ vyhlásenie o zhode je k dispozícii na tejto internetovej adrese: <a href="http://www.alpine.com/e/research/doc/">http://www.alpine.com/e/research/doc/</a>
[TR] Turkey	ALPS ALPINE CO., LTD., Music Halo (iLX-705D/iLX-F905D/iLX-F115D/i905) tipi telsiz cihazın 2014/53/EU sayılı Direktiflere uygun olduğunu beyan eder. AB uygunluk beyanının tam metni şu adreste bulunur: <a href="http://www.alpine.com/e/research/doc/">http://www.alpine.com/e/research/doc/</a>



### ENGLISH

#### **Information on Disposal of Old Electrical and Electronic Equipment and Battery (applicable for countries that have adopted separate waste collection systems)**

If you want to dispose this product, do not mix it with general household waste. There is a separate collection system for used electronic products in accordance with legislation that requires proper treatment, recovery and recycling. Contact your local authority for details in locating a recycle facility nearest to you. Proper recycling and waste disposal will help conserve resources whilst preventing detrimental effects on our health and the environment.

### DEUTSCH

#### **Informationen zur Entsorgung von Elektro- und Elektronikgeräten und Batterien (anwendbar für Länder, die ein separates Sammelsystem übernommen haben)**

Wenn Sie dieses Produkt entsorgen wollen, entsorgen Sie dies nicht über den normalen Hausmüll. Es gibt ein separates Sammelsystem für gebrauchte elektronische Geräte in Einklang mit den Rechtsvorschriften, die eine angemessene Behandlung, Verwertung und Recycling erfordert. Kontaktieren Sie Ihre lokale Behörde für Details bei der Suche nach einer Recycling-Anlage Ihrer Nähe. Ordnungsgemäße Verwertung und Entsorgung trägt dazu bei, Ressourcen zu schonen und schädliche Auswirkungen auf unsere Gesundheit und die Umwelt zu verhindern.

### FRANÇAIS

#### **Information sur le traitement des Déchets Electriques et Electroniques (DEEE), pour les pays ayant adoptés un traitement séparés de ces déchets**

Si vous possédez des appareils Electriques ou Electroniques usagés, ne les jetez pas dans le système général. Conformément à la Directive Européenne, transposée dans votre pays, il existe un système séparé de recyclage et de traitement de ces déchets. Veuillez contacter l'administration locale afin de prendre connaissance du lieu de recyclage et de traitement le plus proche de chez vous. Ce système est destiné à protéger l'environnement.

### ESPAÑOL

#### **Información sobre la eliminación de Viejos Equipos Eléctricos y Electrónicos, así como Baterías (aplicable en los países que han adoptado sistemas de recogida selectiva de residuos)**

Si desea deshacerse de este producto, no lo mezcle con los residuos generales de su hogar. Existe un sistema de recogida selectiva para aparatos electrónicos usados de acuerdo a la legislación, que requiere un tratamiento adecuado de recuperación y reciclado. Póngase en contacto con las autoridades locales para obtener más información sobre el punto de recogida y tratamiento más cercano. El apropiado reciclado y eliminación de residuos ayuda a conservar los recursos y a contribuir en la prevención de los efectos negativos y perjudiciales sobre nuestra salud y el medio ambiente.

### ITALIANO

#### **Avvertenze sullo smaltimento di dispositivi elettronici usati o delle batterie (valido per quei paesi che hanno adottato il sistema di raccolta differenziata)**

In caso di smaltimento del prodotto, non gettarlo assolutamente insieme ai rifiuti domestici. Esiste un sistema di raccolta differenziata per prodotti elettronici conforme alle leggi che regolano il trattamento, il deposito e il riciclo. Contattare le autorità locali per ulteriori informazioni e per trovare il punto di raccolta più vicino alla vostra abitazione. Un corretto riciclo e un appropriato smaltimento dei rifiuti contribuirà a conservare le risorse e a prevenire effetti nocivi sia sulla salute che sull'ambiente.





**ALPS ALPINE NORTH AMERICA, INC.**

1500 Atlantic Blvd,  
Auburn Hills, Michigan 48326, U.S.A.  
Phone 1-800-ALPINE-1 (1-800-257-4631)

**ALPINE ELECTRONICS OF AUSTRALIA PTY. LIMITED**

161-165 Princes Highway,  
Hallam Victoria 3803, Australia  
Phone 03-8787-1200

**ALPS ALPINE EUROPE GmbH**

Ohmstrasse 4, 85716 Unterschleissheim, Germany  
Phone: +49 (0) 89-32 42 640  
For contact information on your respective country,  
please visit [www.alpine-europe.com](http://www.alpine-europe.com).

**ALPS ALPINE EUROPE GmbH**

Aurora House, Deltic Avenue  
Rooksley, Milton Keynes, MK13 8LW  
United Kingdom  
Phone: 0345-313-1640

**ALPS ALPINE ASIA CO., LTD.**

The 9th Towers, Tower B, 24th Floor, Unit TNB01-03,  
33/4 Rama 9 road, Huay Kwang, Bangkok, 10310, Thailand  
Phone +66 (2) 090 9596

**ALPS ALPINE CO., LTD.**

20-1 Yoshima Industrial park,  
Iwaki, Fukushima, Japan 970-1192  
Phone 0246-36-4111

YAMAGATA THAILAND HQ

324 Moo 4, Bangpoo Industrial Estate Soi 6B,  
Sukhumvit Road, T.Prasa, A.Muang Samutprakarn,  
Samutprakarn 10280

Designed by ALPS ALPINE Japan

Printed in Thailand

68-41657Z79-B. (Y\_A5)